

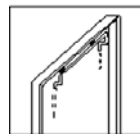

Designer Frames II (Square Corners)

- Stock colours: Pewter (Light Grey), Medium Grey, Almond, Brown and Black. White by special order.
- Holds 1/16" thick material.
- Plates can be mounted with adhesive-backed 3M DUAL LOCK™ so that they are tamper resistant but still removable with a suction cup.
- 1/4" frame thickness.
- Inside dimensions are 1/8" smaller than size shown to get maximum yield put of sign material. (ie. 2" x 8" is 1-7/8" x 7-7/8")

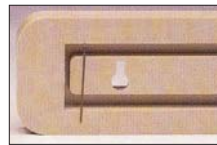
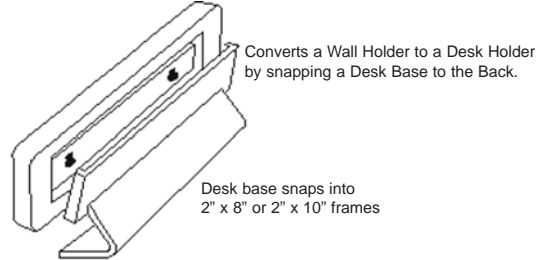
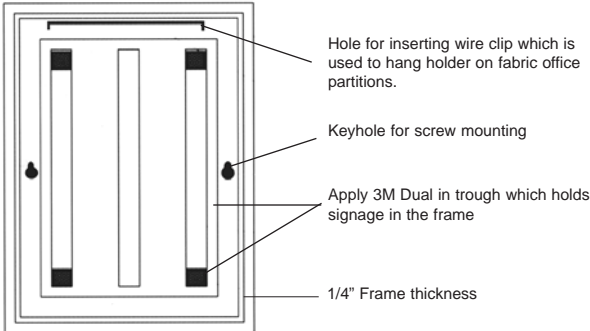

Insert Wire Clip thru holes located at the top of the frame, to hang holder on fabric office partitions.

DESIGNER WALL AND DESK HOLDER

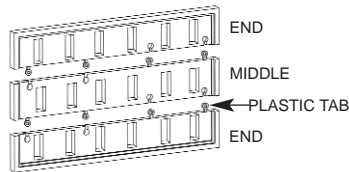
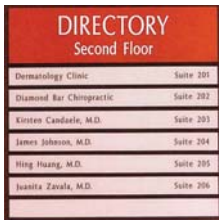

FRAME SIZE	ALMOND	BLACK	LT. GREY	MED. GREY	BROWN
2" x 4"	93-024A	93-024B	93-024P	93-024G	93-024R
2" x 8"	93-028A	93-028B	93-028P	93-028G	93-028R
2" x 10"	93-210A	93-210B	93-210P	93-210G	93-210R
4" x 4"	93-044A	93-044B	93-044P	93-044G	93-044R
4" x 8"	93-048A	93-048B	93-048P	93-048G	93-048R
4" x 10"	93-410A	93-410B	93-410P	93-410G	93-410R
6" Desk Base	91-000A	91-000B	91-000P	91-000G	91-000R
6" x 6"	93-066A	93-066B	93-066P	93-066G	93-066R
6" x 8"	93-068A	93-068B	93-068P	93-068G	93-068R
8" x 8"	93-088A	93-088B	93-088P	93-088G	93-088R
2" x 12" END	93-12ENA	93-12ENB	93-12ENP	93-12ENG	93-12ENR
2" x 12" MIDDLE	93-12MDA	93-12MDB	93-12MDB	93-12MDB	93-12MDB

- Two end pieces make a 4" x 12" Frame.
- Adding a 2" middle section allows the Frame to be increased by 2" increments with each additional section.
- Section fit together by rotating plastic tabs into plastic Barrels.

DOUBLE-SIDED CORRIDOR BRACKETS

- Corridor bracket mounts in two places with concealed screws. (included)

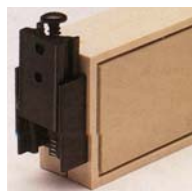

FRAME SIZE	ALMOND	BLACK	LT. GREY	MED. GREY	BROWN
2" x 10"	94-210A	94-210B	94-210P	94-210G	94-210R
4" x 12"	94-412A	94-412B	94-412P	94-412G	94-412R
6" x 6"	94-066A	94-066B	94-066P	94-066G	94-066R
6" x 12"	94-612A	94-612B	94-612P	94-612G	94-612R
8" x 8"	94-088A	94-088B	94-088P	94-088G	94-088R
12" x 12"	94-122A	94-122B	94-122P	94-122G	94-122R