



HOLDERS & FRAMES

2023



BRANDI EMBERLIN
ART DIRECTOR

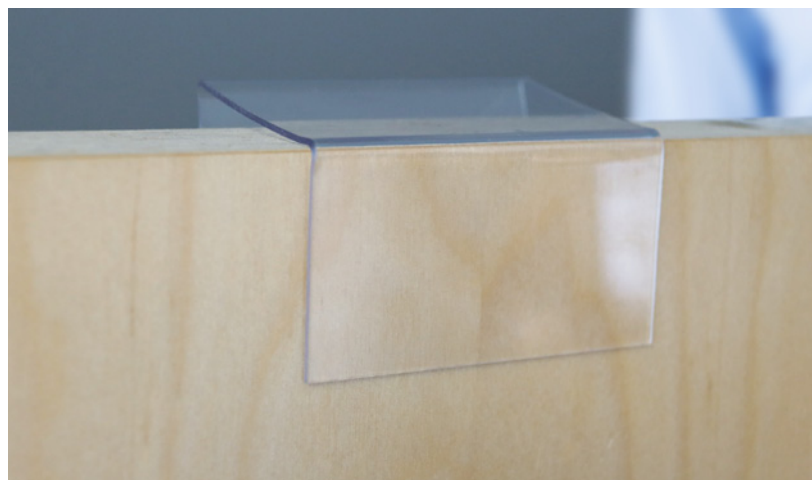

Contents

WALL HOLDERS 04

1/16" Aluminum Wall Holders	04
1/16" Aluminum Ribbed Wall Holders	07
1/16" Aluminum Double Wall Holders	08
1/8" Aluminum Wall Holders	09

DESK HOLDERS 10

1/16" Aluminum Desk Holders	10
1/16" Aluminum Ribbed Desk Holders	11
Raised Aluminum Desk Holders	12

DESK BASES 13

Design	13
Architect	14
Traditional	14
Sign	15
Plastic	16

PLASTIC FRAMES & INSERTS 17

Design Round	17
Design Square	18
Architect Round	19
Architect Square	20
Inserts for Architect Frames	21

CORRIDOR & METAL FRAMES 22

Corridor & Corridor/Ceiling Mount	22
Euro	24
Curves	25
Premier	26
Architect Aluminum	27

CUSTOM FRAMES 29

Euro Series	30
Architect Aluminum Series	31
Premier Series	32

MOUNTING & STANDOFFS 33

Gripper	33
Surface Mount Kit	33
CESCO Standoffs	34

FRAME ACCESSORIES 35

Suction Cups & Partition Pins	35
Cubicle Hangers, CESCO Dual-Lock	36
Wire Clips & Corridor Substrate Hardware Mounting	37
Cutting Equipment For Inserts	38

CESCO Wall Holders

1/16" Material Thickness

Anodized aluminum CESCO Wall Holders have a clean, modern look ideal for professional nameplates or wayfinding and directional signage.

Two counter-sunk holes* for standard screw mounting.
 *39" pieces do not come with mounting holes.

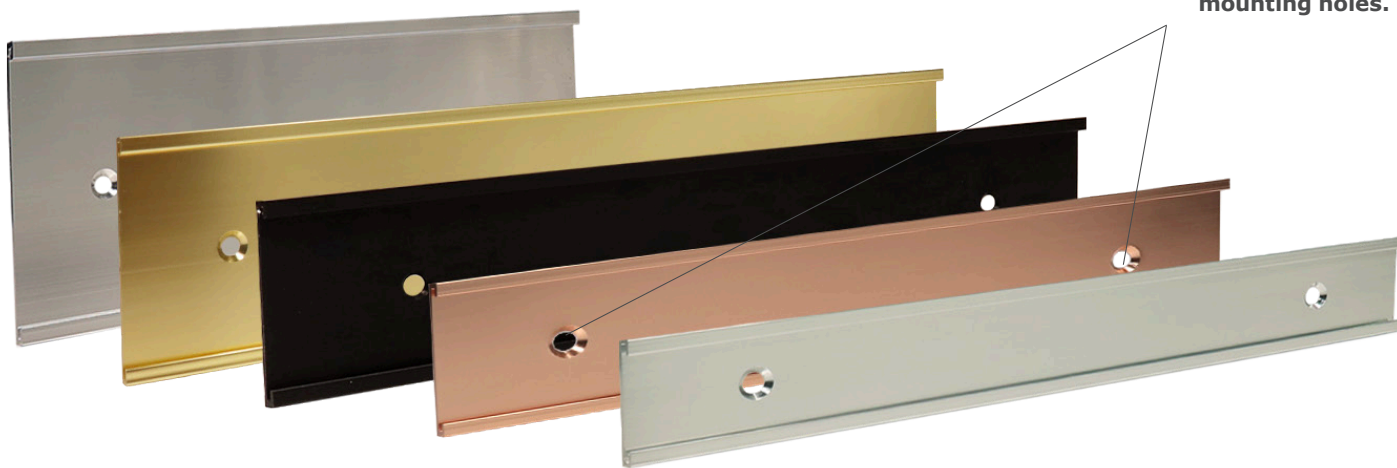

Finished Example

Available in five anodized finishes:

*Polished anodized finish



Matte Black



*Rose Gold



Satin Silver



*Silver



*Yellow Gold

Looking for a custom cut size?

Request a custom quote at csr@cesco.ca.

Insert Height	Item Number	Color	Length
3/4"	944R 204	Silver	4"
	944R 206	Silver	6"
	944R 239	Silver	39"

Insert Height	Item Number	Color	Length
1"	928R 203NH	Silver	3"
	928R 104	Rose Gold	4"
	928R 204	Silver	4"
	928R 406	Matte Black	6"
	928R 106	Rose Gold	6"
	928R 206	Silver	6"
	928R 408	Matte Black	8"
	928R 108	Rose Gold	8"
	928R 208	Silver	8"
	928R 410	Matte Black	10"
	928R 110	Rose Gold	10"
	928R 210	Silver	10"
	928R 212	Silver	12"
	928R 439	Matte Black	39"
	928R 339	Satin Silver	39"
	928R 239	Silver	39"

39" pieces do not come with mounting holes.

1/16" Material Thickness

Insert Height	Item Number	Color	Length
1-1/2"	929R 204	Silver	4"
	929R 406	Matte Black	6"
	929R 206	Silver	6"
	929R 408	Matte Black	8"
	929R 108	Rose Gold	8"
	929R 208	Silver	8"
	929R 110	Rose Gold	10"
	929R 210	Silver	10"
	929R 112	Rose Gold	12"
	929R 212	Silver	12"
	929R 439	Matte Black	39"
	929R 139	Rose Gold	39"
	929R 339	Satin Silver	39"

Insert Height	Item Number	Color	Length
3"	937R 108	Rose Gold	8"
	937R 208	Silver	8"
	937R 110	Rose Gold	10"
	937R 210	Silver	10"
	937R 412	Matte Black	12"
	937R 112	Rose Gold	12"
	937R 212	Silver	12"
	937R 439	Matte Black	39"
	937R 339	Satin Silver	39"
	937R 239	Silver	39"

Insert Height	Item Number	Color	Length
2"	936R 204	Silver	4"
	936R 406	Matte Black	6"
	936R 206	Silver	6"
	936R 408	Matte Black	8"
	936R 108	Rose Gold	8"
	936R 308	Satin Silver	8"
	936R 208	Silver	8"
	936R 708	Yellow Gold	8"
	936R 209	Silver	9"
	936R 410	Matte Black	10"
	936R 310	Satin Silver	10"
	936R 110	Rose Gold	10"
	936R 210	Silver	10"
	936R 710	Yellow Gold	10"
	936R 412	Matte Black	12"
	936R 112	Rose Gold	12"
	936R 212	Silver	12"
	936R 712	Yellow Gold	12"
	936R 439	Matte Black	39"
	936R 139	Rose Gold	39"
	936R 339	Satin Silver	39"
	936R 239	Silver	39"
	936R 739	Yellow Gold	39"

Insert Height	Item Number	Color	Length
4"	949R 108	Rose Gold	8"
	949R 208	Silver	8"
	949R 210	Silver	10"
	949R 112	Rose Gold	12"
	949R 212	Silver	12"
	949R 439	Matte Black	39"
949R 339	Satin Silver	39"	

Insert Height	Item Number	Color	Length
2-1/2"	925R 108	Rose Gold	8"
	925R 208	Silver	8"
	925R 439	Matte Black	39"
	925R 339	Satin Silver	39"

39" pieces do not come with mounting holes.



CESSCO WALL HOLDERS

1/16" Material Thickness - No Mounting Holes

Anodized aluminum CESCO Wall Holders have a clean, modern look ideal for directory signage.



Finished Example

Available in three anodized finishes:

*Polished anodized finish



Matte Black



Satin Silver



*Silver



Insert Height	Item Number	Color	Length
1"	928R 203NH	Silver	3"
	928R 304NH	Satin Silver	4"
	928R 406NH	Matte Black	6"
	928R 409NH	Matte Black	9"
	928R 412NH	Matte Black	12"

Insert Height	Item Number	Color	Length
1-1/2"	929R 306NH	Satin Silver	6"

Insert Height	Item Number	Color	Length
2"	936R 306NH	Satin Silver	6"
	936R 308NH	Satin Silver	8"

See pages 4-5 for 39" no holes wall options.

Ribbed 1/16" Material Thickness

Anodized aluminum ribbed CESCO Wall Holders have a clean, modern look ideal for professional nameplates or wayfinding and directional signage.

Two counter-sunk holes* for standard screw mounting.
***39" pieces do not come with mounting holes.**



Finished Example

Available in three anodized finishes:

*Polished anodized finish



Matte Black



* Rose Gold



* Silver

Insert Height	Item Number	Color	Length
2"	958R 408	Matte Black	8"
	958R 108	Rose Gold	8"
	958R 208	Silver	8"
	958R 410	Matte Black	10"
	958R 110	Rose Gold	10"
	958R 210	Silver	10"
	958R 439	Matte Black	39"
	958R 239	Silver	39"
	958R 139	Rose Gold	39"

39" pieces do not come with mounting holes.

Looking for a custom cut size?

Request a custom quote at csr@cesco.ca.



Double Wall 1/16" Material Thickness

Anodized aluminum CESCO Double Wall Holders have a clean, modern look ideal for directory or wayfinding signage.



Two counter-sunk holes* for standard screw mounting.
*39" pieces do not come with mounting holes.



Finished Example

Available in three anodized finishes:

*Polished anodized finish



Matte Black



Satin Silver



* Silver

Insert Height	Item Number	Color	Length
1"/1"	9104R 208	Silver	8"
	9104R 210	Silver	10"
	9104R 439	Matte Black	39"
	9104R 239	Silver	39"
	9104R 339	Satin Silver	39"

39" pieces do not come with mounting holes.

Looking for a custom cut size?

Request a custom quote at csr@cesco.ca.

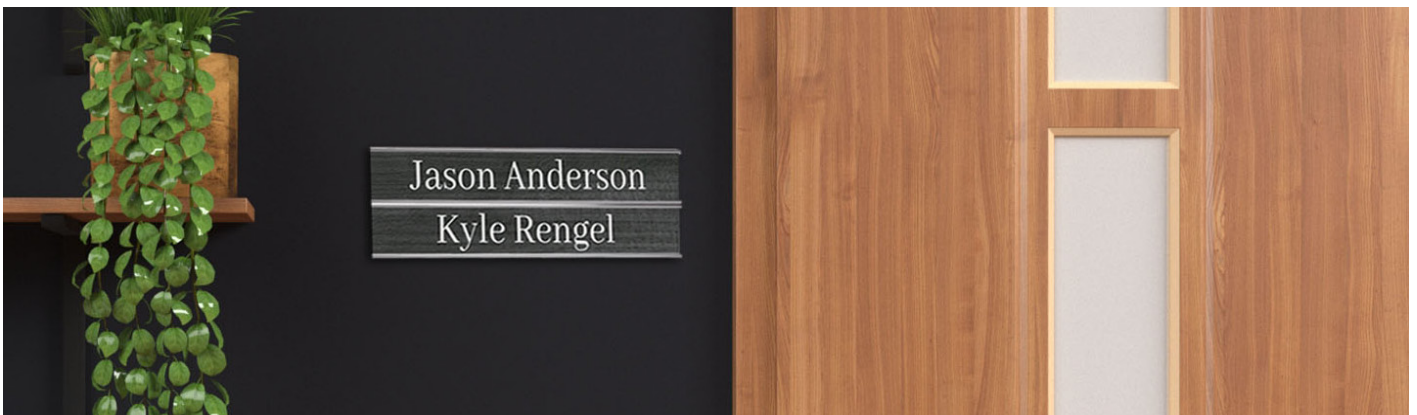

1/8" Material Thickness

Anodized aluminum CESCO Wall Holders have a clean, modern look ideal for professional nameplates or wayfinding and directional signage.

Two counter-sunk holes* for standard screw mounting.
***39" pieces do not come with mounting holes.**



Finished Example

Available in four anodized finishes:

* Polished anodized finish



Matte Black



Rose Gold



Silver



Yellow Gold

Insert Height	Item Number	Color	Length
2"	994R 208	Silver	8"
	994R 410	Matte Black	10"
	994R 110	Rose Gold	10"
	994R 210	Silver	10"
	994R 710	Yellow Gold	10"
	994R 212	Silver	12"
	994R 439	Matte Black	39"
	994R 139	Rose Gold	39"
	994R 239	Silver	39"
	994R 739	Yellow Gold	39"

Insert Height	Item Number	Color	Length
3"	993R 339	Satin Silver	39"
	993R 239	Silver	39"

39" pieces do not come with mounting holes.

Looking for a custom cut size?
 Request a custom quote at csr@cesco.ca.



CESCO Desk Holders

1/16" Material Thickness

Anodized aluminum CESCO Desk holders have a clean, modern look ideal for professional desk nameplates.



Finished Example

Available in five anodized finishes:

* Polished anodized finish



Matte Black

* Rose Gold

Satin Silver

* Silver

* Yellow Gold

Looking for a custom cut size?

Request a custom quote at csr@cesco.ca.

Insert Height	Item Number	Color	Length
2"	948R 408	Matte Black	8"
	948R 108	Rose Gold	8"
	948R 308	Satin Silver	8"
	948R 208	Silver	8"
	948R 708	Yellow Gold	8"
	948R 410	Matte Black	10"
	948R 110	Rose Gold	10"
	948R 310	Satin Silver	10"
	948R 410	Silver	10"
	948R 710	Yellow Gold	10"
	948R 412	Matte Black	12"
	948R 112	Rose Gold	12"
	948R 212	Silver	12"
	948R 412	Satin Silver	12"
	948R 712	Yellow Gold	12"
	948R 439	Matte Black	39"
	948R 139	Rose Gold	39"
948R 239	Silver	39"	
948R 739	Yellow Gold	39"	

Ribbed 1/16" Material Thickness

Anodized aluminum CESCO Ribbed Desk Holders have a clean, modern look ideal for professional desk nameplates.

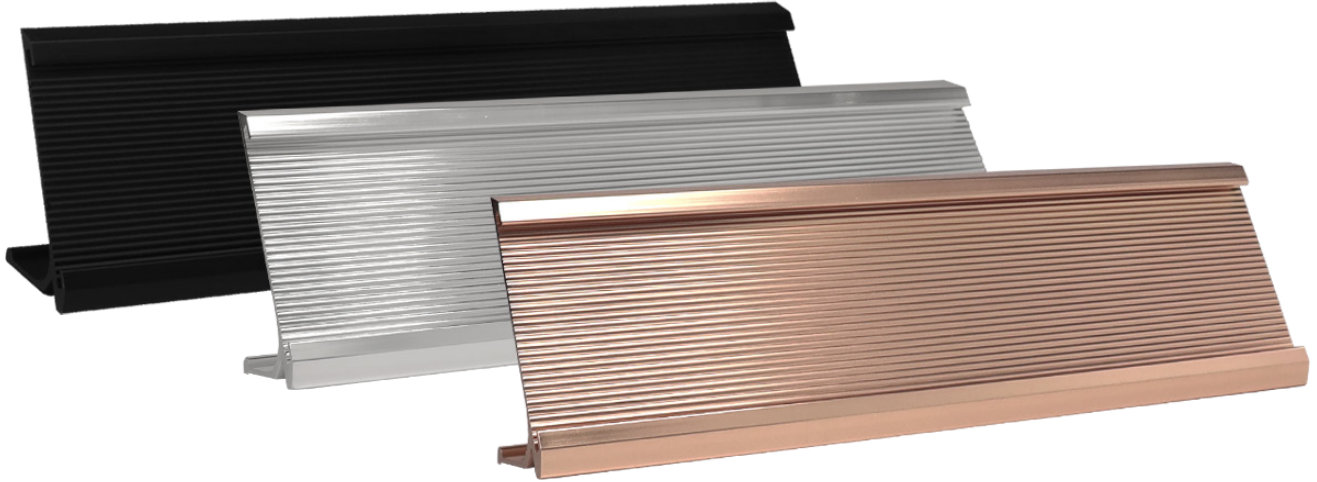

Available in three anodized finishes:

* Polished anodized finish



Matte Black



* Rose Gold



* Silver



Finished Example

Insert Height	Item Number	Color	Length
2"	959R 408	Matte Black	8"
	959R 108	Rose Gold	8"
	959R 208	Silver	8"
	959R 410	Matte Black	10"
	959R 110	Rose Gold	10"
	959R 210	Silver	10"



Raised 1/16" Material Thickness

Anodized aluminum CESCO Raised Desk Holders will take professional desk nameplates to the next level with an elevated base.



Available in two anodized finishes:

• Polished anodized finish



• Rose Gold



• Silver



Finished Example

Insert Height	Item Number	Color	Length
2"	930R 108	Rose Gold	8"
	930R 208	Silver	8"
	930R 110	Rose Gold	10"
	930R 210	Silver	10"



CESCO Desk Bases

CESCO Design Desk Base

CESCO Design Desk Base is designed to easily attach to any 2"x 8" or 2" x 10" CESCO Design plastic frame to create an easy desk sign. Easily snap in CESCO Design frames using the pins and mounting holes on back of frame.

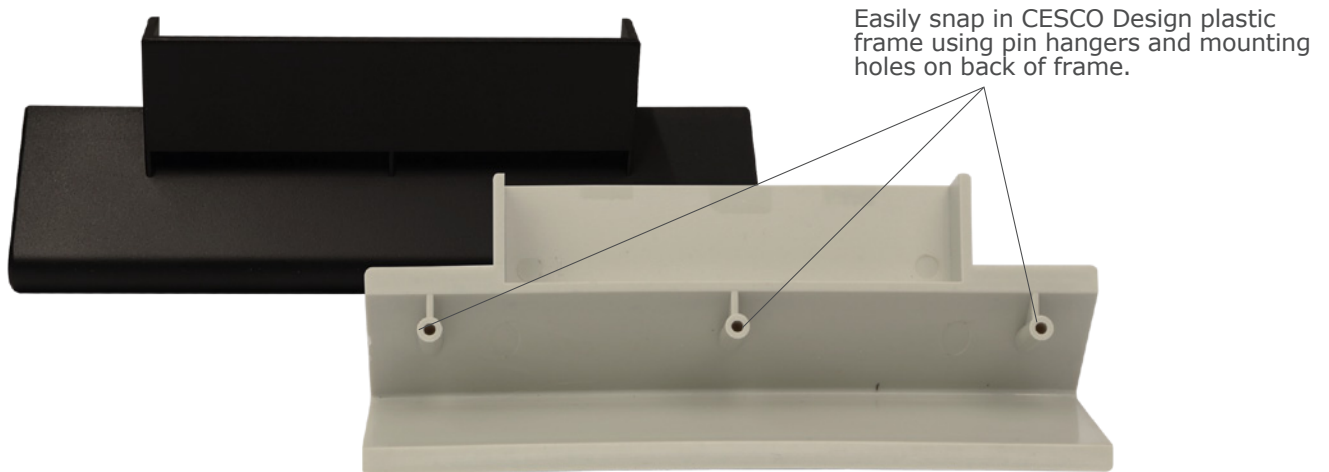

Desk Base with Plastic Frame without insert.

Available in two finishes:



Black



Pewter

Height	Item Number	Color
2-1/2"	91R 000B	Black
	91R 000P	Pewter



Desk Base with Plastic Frame with insert.



See pages 17-18 for Desk Frames options.

CESCO Architect Desk Base

CESCO Architect Desk Base is designed to easily attach to any 1.75" x 9.125" CESCO Architect frame to create an easy desk sign. Easily snap in CESCO Architect frames using the pins and mounting holes on back of frame.

Easily snap in CESCO Architect frames using the pins and mounting holes on back of frame.

Color
Black

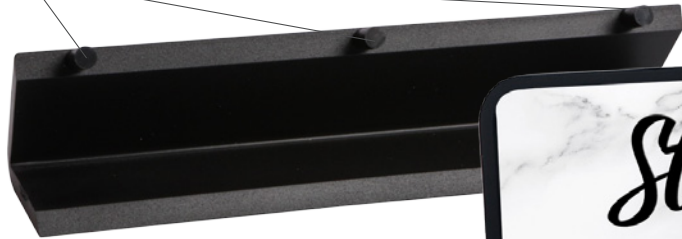

Desk Base with Plastic Frame without insert.



Desk Base with Plastic Frame with insert.

Available in Black:



See pages 19-20 for Desk Frames options.

CESCO Traditional Aluminum Desk Base

Anodized aluminum Traditional Desk Bases have a clean, modern look with a base channel and open top perfect for displaying message signs or nameplates. Accommodates inserts up to 1/16" thick. 2" maximum sign height.

Slide insert into slot.

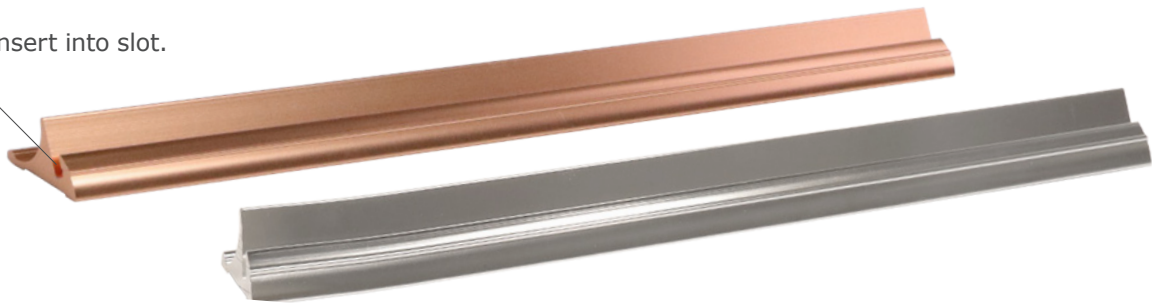

Available in two anodized finishes:

* Polished anodized finish



* Rose Gold



* Silver



Finished Example

Height	Item Number	Color	Length
3/4"	950R 208	Silver	8"
	950R 108	Rose Gold	8"
	950R 210	Silver	10"
	950R 110	Rose Gold	10"

CESCO Aluminum Sign Base

Anodized aluminum CESCO Anodized Sign Bases have a clean, modern look with a base channel and open top perfect for displaying message signs or nameplates. Accommodates inserts up to 1/8" thick.

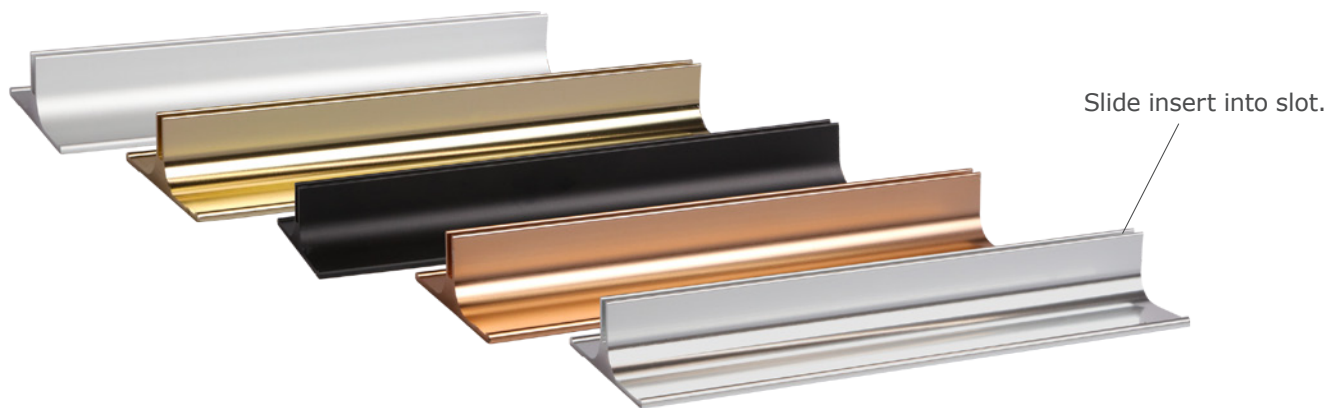

Available in five anodized finishes:

*Polished anodized finish



Matte Black



*Rose Gold



Satin Silver



*Silver



*Yellow Gold



Finished Example

Height	Item Number	Color	Length
2-1/2"	922R 439	Matte Black	39"
	922R 139	Rose Gold	39"
	922R 339	Satin Silver	39"
	922R 239	Silver	39"
	922R 739	Yellow Gold	39"

Looking for a custom cut size?

Request a custom quote at csr@cesco.ca.



CESCO Plastic Desk Base

CESCO Plastic Desk Bases are the perfect low profile base for any sign or desk plate. The base has a single angled slot and no top channel which allows for various height inserts. Accommodates inserts up to 1/16" thick.

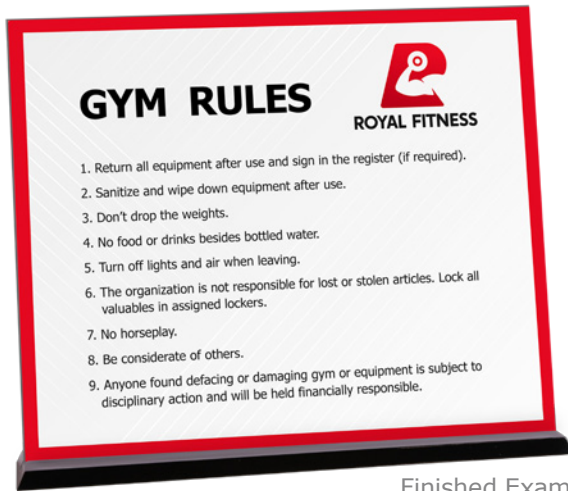

Finished Example

Available in two finishes:

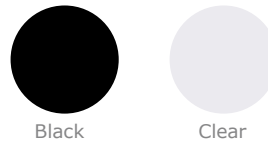

Item Number	Color	Length
910R 408	Black	8"
910R 708	Clear	8"
910R 410	Black	10"
910R 710	Clear	10"

CESCO DESK BASES



CESCO Plastic Frames

CESCO Design Round Plastic Frames for 1/8" Material Thickness

CESCO Design series is an injection molded plastic sign system featuring modern, 3/8" rounded corners. Designed with two keyholes on the back for solid surface mounting or pin hangers for easy fabric mounting to cubicle walls. Works great with CESCO Dual-Lock and compatible with CESCO Sign Desk Bases (sold separately).



Finished Example with Insert

Available in five finishes:

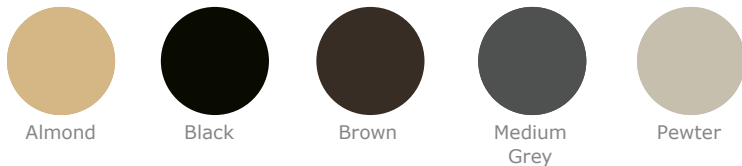

See page 13 for Desk Base options.

Insert Height	Item Number	Color	Length
2"	91R 028A	Almond	8"
	91R 028B	Black	8"
	91R 210BR	Brown	8"
	91R 210G	Medium Grey	8"
	91R 028P	Pewter	8"
	91R 210B	Black	10"
	91R 028BR	Brown	10"
	91R 210G	Medium Grey	10"
	91R 210P	Pewter	10"

Insert Height	Item Number	Color	Length
4"	91R 044B	Black	4"

Insert Height	Item Number	Color	Length
6"	91R 066G	Medium Grey	6"
	91R 066B	Black	6"

Insert Height	Item Number	Color	Length
8"	91R 088B	Black	8"
	91R 066B	Black	6"

The frame size listed are inside dimensions.

CESCO Design Square Plastic Frames for 1/8" Material Thickness

CESCO Design series is an injection molded plastic sign system featuring modern, square corners. Designed with two keyholes on the back for solid surface mounting or pin hangers for easy fabric mounting to cubicle walls. Works great with CESCO Dual-Lock and compatible with CESCO Sign Desk Bases (sold separately).



Two keyholes for solid surface mounting or pin hangers.



Finished Example with Insert

See page 13 for Desk Base options.

Available in three finishes:



Black



Medium Grey



Pewter

Insert Height	Item Number	Color	Length
2"	93R 028B	Black	8"
	93R 210B	Black	10"
	93R 210G	Medium Grey	10"
	93R 210P	Pewter	10"

The frame size listed are inside dimensions.



CESCO Architect Round Plastic Frames for 1/8" and 1/16" Material Thickness

CESCO Architect is a series injection molded plastic frame available in 5/16" round or square corners that allows you to create a comprehensive sign system based on your customers request. Easily mix and match round and square cornered frames within the series to create a unified look and feel. CESCO Architect frames are designed with two mounting holes on the back to easily attach to walls and other rigid surfaces. Works great with CESCO Dual-Lock and compatible with CESCO Architect Desk Bases and inserts (sold separately).

Two mounting holes for solid surface mounting or pin hangers.



Finished Example with Insert

Insert Height	Item Number	Color	Length
1.75"	97129R A	Almond	9.125"
	97129R B	Black	9.125"
	97129R BR	Brown	9.125"
	97129R P	Pewter	9.125"
	97129R WT	White	9.125"

The frame size listed are insided dimensions.

Available in five finishes:



See page 14 for Desk Base options.



CESCO Architect Square Plastic Frames for 1/8" and 1/16" Material Thickness

CESCO Architect is a series injection molded plastic frame available in 5/16" round or square corners that allows you to create a comprehensive sign system based on your customers request. Easily mix and match round and square cornered frames within the series to create a unified look and feel. CESCO Architect frames are designed with two mounting holes on the back to easily attach to walls and other rigid surfaces. Works great with CESCO Dual-Lock and compatible with CESCO Architect Desk Bases and inserts (sold separately).

Two mounting holes for solid surface mounting or pin hangers.

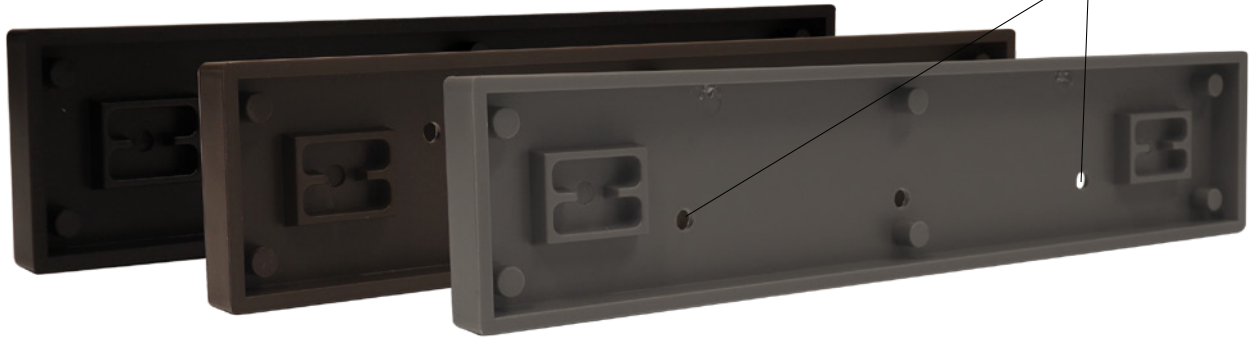

Finished Example with Insert

Insert Height	Item Number	Color	Length
1.75 "	98129R B	Black	9.125"
	98129R BR	Brown	9.125"
	98129R G	Medium Grey	9.125"

The frame size listed are inside dimensions.

Available in three finishes:

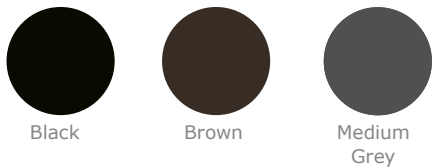

Black

Brown

Medium Grey

See pages 14 for Desk Base options.



CESCO Inserts for Architect Frames

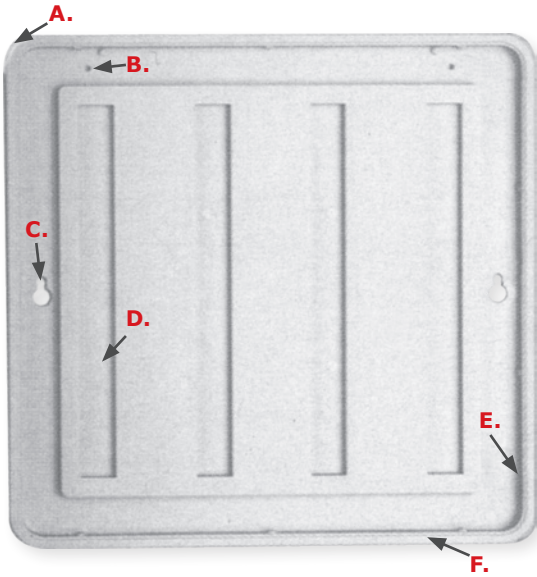

- A.** 3/8" inside radius
- B.** Pin for mounting to fabric covered partitions
- C.** Keyhole mounting
- D.** 1/2" trough for mounting 3M DUAL LOCK™
- E.** Front Reveal
- F.** 1/8" frame thickness

Design Frames

Design Frame System is designed for quality interior signage. Several unique features offered by this system will make designing and mounting interior signage simple. Frames are 1/8" smaller than designated size to provide maximum yield of 24" x 48" sheet when using saw cut or sheared strips.

- Five (5) colours: Light Grey (Pewter), Medium Grey, Almond, Black, Brown
- Designed for 1/16" material, with 3/8" radius corners
- Keyhole mounting allows for permanent or removable frames
- Wire clip mounts into frame for hanging on office partitions
- Snap Wire in place between frame and peg. Apply adhesive inside frame over wire if permanent wire placement is required.
- Features Dual Lock™ fastening system for attaching insert strips. Tamper resistant, but plates can be removed with suction cup.
- 'Header' messages can be permanently mounted with tape, while Dual Lock™ tabs can be placed at ANY LEVEL for interchangeable messages
- Double-sided frames are available for corridor brackets. Bracket mounts to plate. Bracket is mounted to wall with concealed screws.

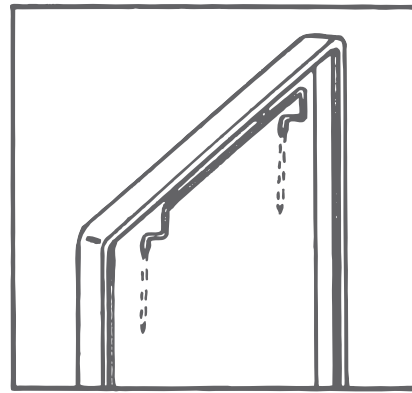
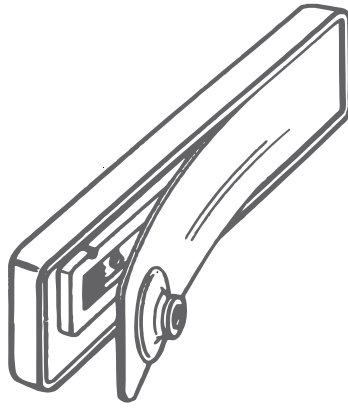
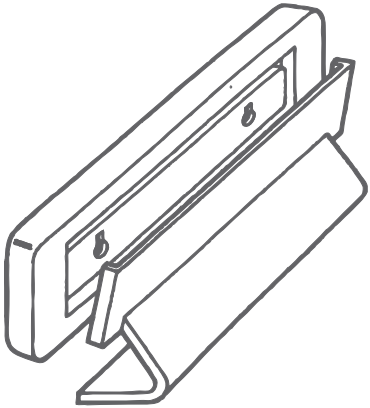

	99D-512 1/2" x 12" Dual Lock™	Dense mounts to trough Light mounts to plate
	SUC-000 Suction Cup 1 1/2"	Removes plates from holders

	99W-350 3 1/2" Wire Clip	For frames 6" and under
	99W-600 6" Wire Clip	For frames 8" and larger

Inserts

Inserts can be cut from classic and durable two-ply Rowmark plastics or Rowmark single-layer LaserMax and other products. Use 3/8" radius die for round corners. Can be personalized with laser engraving, rotary engraving, or UV-LED and standard digital printers. See web link for more information.



Multiple colours available. See our 2023 *Laserable Catalogue* starting on [Page 4](#)



CESCO Corridor & Metal Frames

CESCO Corridor Wall Mount with 1/8" Slot

CESCO Corridor Mount brackets are designed to hold single and double-sided signs at a 90 degree angle to the wall. Perfect for wayfinding signage in your next project.

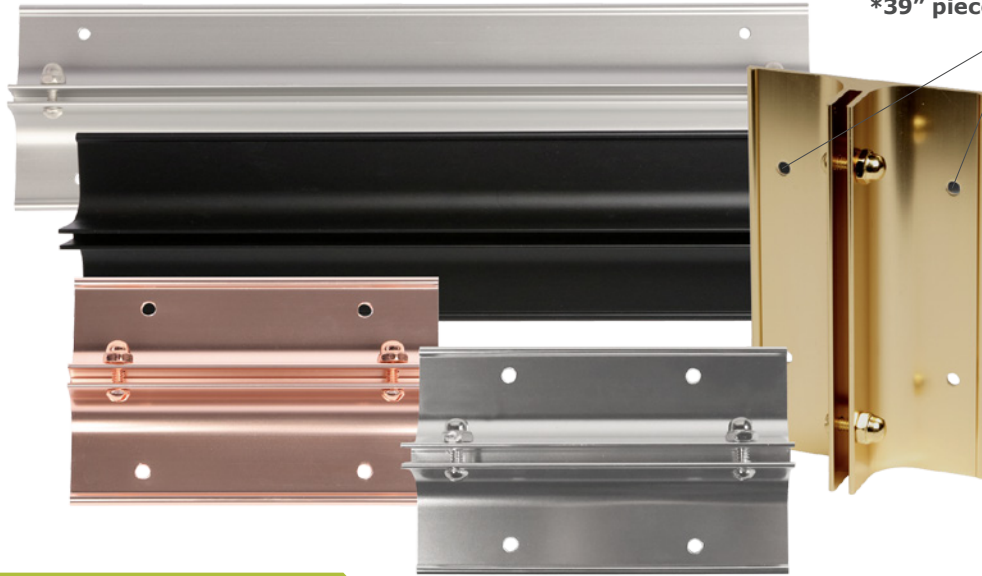

Four counter-sunk holes* for standard screw mounting.
*39" pieces do not come with mounting holes.

Looking for a custom cut size?

Request a custom quote at csr@cesco.ca.

Height	Item Number	Color
2"	938R 102	Rose Gold
	938R 202	Silver

Height	Item Number	Color
3"	938R 103	Rose Gold
	938R 203	Silver
	938R 703	Yellow Gold

Height	Item Number	Color
4"	938R 104	Rose Gold
	938R 304	Satin Silver
	938R 204	Silver
	938R 704	Yellow Gold

Height	Item Number	Color
5"	938R 305	Satin Silver
	938R 205	Silver

Height	Item Number	Color
6"	938R 306	Satin Silver
	938R 206	Silver

Height	Item Number	Color
8"	938R 308	Satin Silver

Height	Item Number	Color
10"	938R 310	Satin Silver
	938R 210	Silver

Height	Item Number	Color
12"	938R 312	Satin Silver

Height	Item Number	Color
39"	938R 439	Matte Black
	938R 139	Rose Gold
	938R 339	Satin Silver
	938R 239	Silver
	938R 739	Yellow Gold



Available in five anodized finishes:

Finished Example

*Polished anodized finish



Rose Gold



*Rose Gold



Satin Silver



*Silver



*Yellow Gold

CESCO Corridor and Ceiling Bracket with 1/8" Slot

CESCO Corridor and Ceiling Bracket are double sided and can be mounted perpendicular to the wall or the ceiling. With a concealed mounting system it is CESCO perfect for you next wayfinding or signage project. Double sided tape or adhesive is required for sign installation.



Finished Example



Available in Satin Silver:



Item Number	Color	Length
9CCR 306	Satin Silver	6"
9CCR 308	Satin Silver	8"
9CCR 339	Satin Silver	39"

Looking for a custom cut size?

Request a custom quote at csr@cesco.ca.

CESCO Euro Series Frames (Available for custom order. Submit size)

CESCO Euro Series Frames can be used as a single, stand-alone holder or an entire wayfinding system of frames and complex directories. These frames are vandal and tamper-resistant and offers a choice of a modern, square profile edge to meet any office, industrial and institutional environments. Accommodates inserts up to 1/16" thick.



Available in Satin Silver:



Square Profile Edge

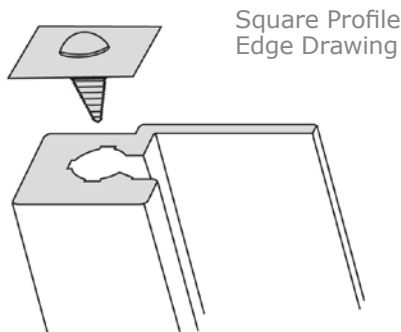

Finished Example

CESCO Curves Frame with Lens (Custom sizes are not available)

The CESCO Curves frame has everything you need for your next signage project. This signage system offers a sleek dimensional, curved profile to meet any office, industrial and institutional environment. CESCO Curves comes with a clear non-glare .020" lens to protect your sign or insert. Accommodates inserts to 1/16" thick without lens.

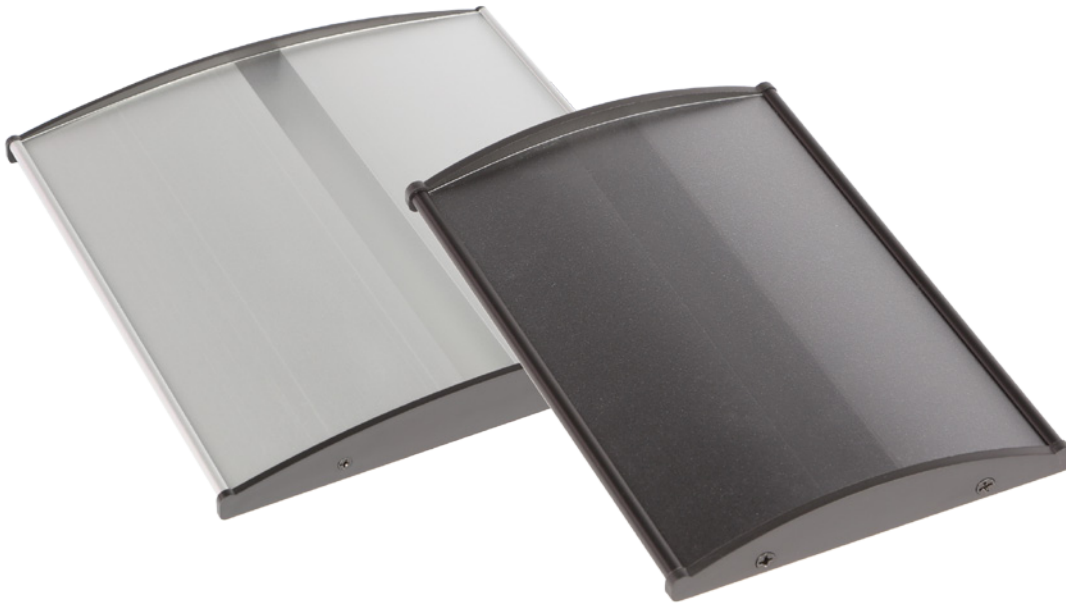

Finished Example

Available in two finishes:



Matte Black



Satin Silver

Insert Height	Color	Length
4"	Matte Black	6"
	Satin Silver	6"
	Matte Black	8"
	Satin Silver	8"

Insert Height	Color	Length
6"	Matte Black	6"
	Satin Silver	6"
	Matte Black	8"
	Satin Silver	8"

Insert Height	Color	Length
8"	Matte Black	6"
	Satin Silver	6"
	Matte Black	8"
	Satin Silver	8"

CESCO Premier Series (Available for custom order. Submit size and colour)

Featuring a classic, high-quality frame style, the CESCO Premier Series is a popular choice for professional custom signage mounting solutions. The frame corners are precision mitered by our craftsman and feature a waterproof acrylic backing board making them light-weight and easy to install.

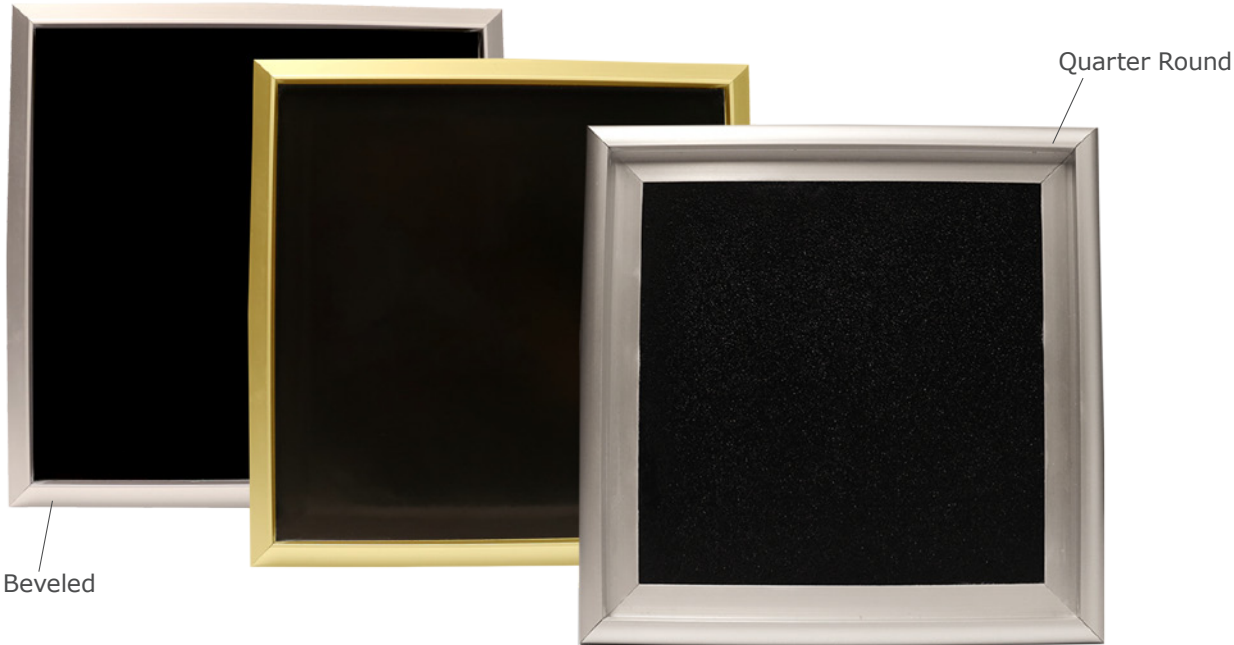

Finished Example

See page 32 for custom Premier options.

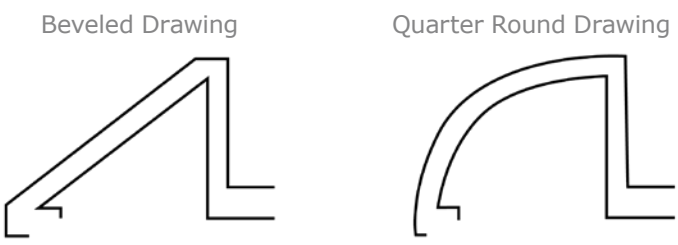

Available in two finishes:

- Polished anodized finish
- Satin Silver
- Yellow Gold

CESCO Architect Aluminum Series (Available for custom order. Submit size and colour)

Precision engineered and built to your size specifications, our CESCO Architect Aluminum Series are a contemporary alternative to display signs in office, industrial, and institutional spaces. All frames are expertly crafted and made to order to fit any installation. Available in square corners and rounded 3/8" or 1/2" radius corners and in 1/8" or 1/16" wall thickness.



Finished Example

Available in four anodized finishes:

* Polished anodized finish



Matte Black



Satin Silver



* Silver



Yellow Gold

Square Drawing



3/8" Radius Drawing

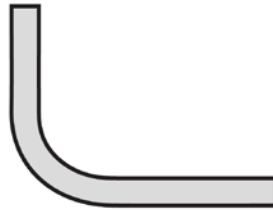

1/2" Radius Drawing

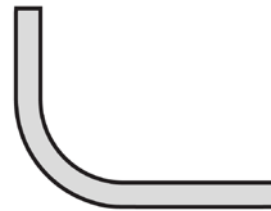

See page 31 for custom Architect Frame options.



CESCO Custom Frames

Looking to create a custom frame?

Our CESCO Euro, Premier, and Architect Series frames can be custom designed to meet your specific requirements. Whether you're looking for a replacement frame to match an existing installation or needing to create an entirely new sign system, we can help you come up with the perfect solution for you and your customer.

Please reach out to one of our friendly sign frame experts and we'll handle the rest! For more information, visit cesco.ca or contact us at csr@cesco.ca or 1 (877) 795-1262.

A \$50 minimum applies to custom frame orders.

A large, vertical sign with a blue background and a black border. It is divided into four horizontal sections. The top section contains the "suncLOUD creative computing" logo (a sun behind a cloud) and the text "IT DEPARTMENT". The second section contains the name "JARROD THOMAS" and the title "VICE PRESIDENT OF IT". The third section contains the name "KATHERAN WARD" and the title "SOFTWARE ENGINEER". The bottom section contains the name "TROY BISHOP" and the title "SOFTWARE ENGINEER".

 **IT DEPARTMENT**

JARROD THOMAS
VICE PRESIDENT OF IT

KATHERAN WARD
SOFTWARE ENGINEER

TROY BISHOP
SOFTWARE ENGINEER



Custom CESCO Euro Series

All Custom CESCO Euro Series are made to order.

CESCO Euro Series Frames can be used as a single, stand-alone holder or an entire wayfinding system of frames and complex directories made to your specifications.

These frames are vandal and tamper-resistant and offers a choice of a modern, square edge or rounded/rolled profile edge to meet any office, industrial and institutional environments.

Features:

- Available in Matte Black, Rose Gold, Satin Silver, Silver and Yellow Gold
- Available in square and round edges
- Sign assemblies are stacked to create directories
- Works great with CESCO Dual-Lock
- Accommodates inserts up to 1/16" thick

Typical Uses include:

- Wayfinding signs
- Directory signs

Square Profile Edge Drawing

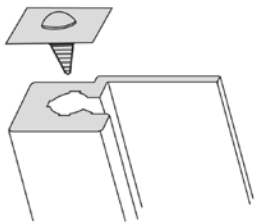

Round Profile Edge Drawing

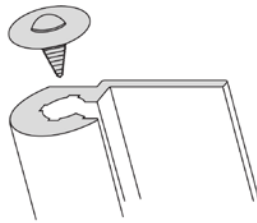

Available in five finishes:

*Polished anodized finish



Matte Black



*Rose Gold



Satin Silver



*Silver



*Yellow Gold

Interested in creating your own custom CESCO Euro sign? Email csr@cesco.ca to get started. *A \$50 minimum applies to custom frame orders.*



Custom CESCO Architect Aluminum Series

All Custom CESCO Architect Aluminum Series are made to order.

Precision engineered and built to your size specifications, our CESCO Custom Architect Aluminum Series are a contemporary alternative to display signs in office, industrial, and institutional spaces made to your specifications.

All frames are expertly crafted and made to order to fit any installation.

Features:

- Available in Matte Black, Rose Gold, Satin Silver, and Silver
- Available in square corners and rounded corners with 3/8" or 1/2" radius sign profiles
- Works great with CESCO Dual-Lock
- Accommodates inserts up to 1/16" thick

Typical Uses include:

- Room number signs
- Wayfinding signs
- Warning signs

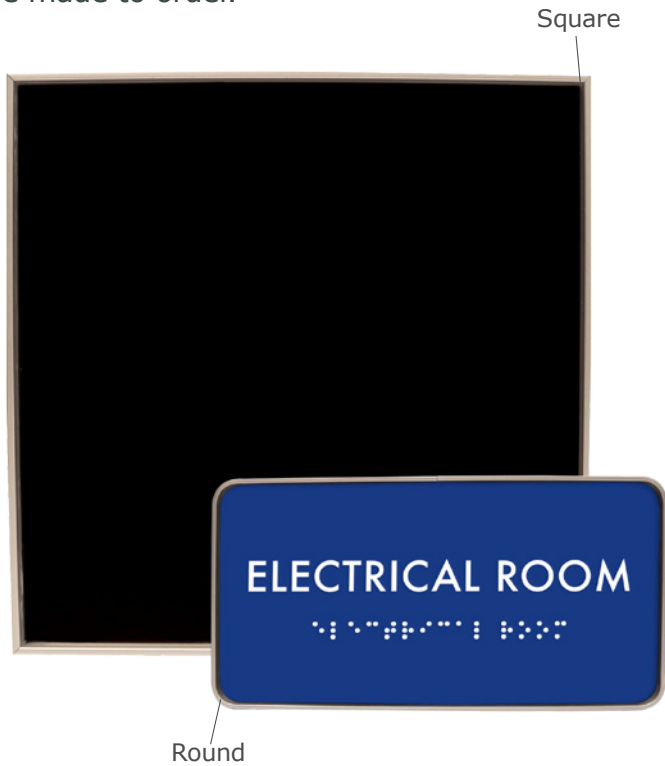

Interested in creating your own custom Architect Aluminum Series sign? Email csr@cesco.ca to get started. *A \$50 minimum applies to custom frame orders.*

Available in three anodized finishes:

• Polished anodized finish

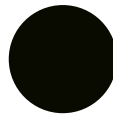

Matte Black



Satin Silver



• Silver

Square Drawing

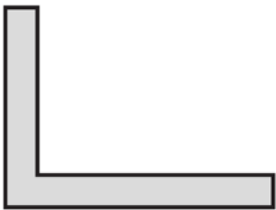

3/8" Radius Drawing

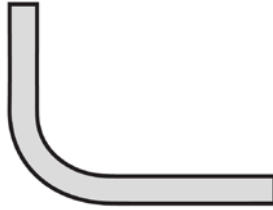

1/2" Radius Drawing

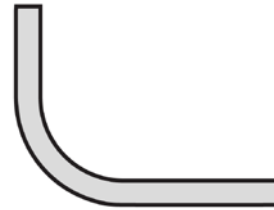



Beveled Drawing

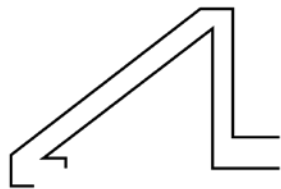

Quarter Round Drawing

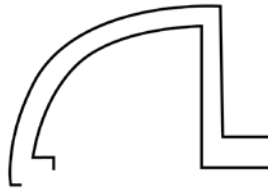

Available in five finishes:

*Polished anodized finish



Matte Black



*Rose Gold



Satin Silver



*Silver



Satin Yellow Gold

Custom CESCO Premier Series

All Custom CESCO Premier Series are made to order.

Featuring a classic, high-quality frame style, the CESCO Premier Series is a popular choice for professional custom signage mounting solutions made to your specifications.

The frame corners are precision mitered by our craftsman and feature a waterproof acrylic backing board structure that makes the frames light-weight and easy to install. Available in beveled or quarter round edge frame style options.

CESCO Premier sign frames work great in office, industrial, or institutional environments.

Features:

- Available in Matte Black, Rose Gold, Satin Silver, Silver and Satin Yellow Gold
- Available in beveled or quarter round edge frame style options
- Available with metal inside for magnetic inserts
- Works great with CESCO Dual-Lock
- Accommodates inserts up to 5/16" thick

Typical Uses include:

- Lobby sign
- Mini directory signs
- Conference room signs

Interested in creating your own custom CESCO Premier sign? Email csr@cesco.ca to get started. *A \$50 minimum applies to custom frame orders.*

Mounting & Standoffs

CESCO Sign Grippers

CESCO Sign Grippers are the perfect solution for decorative sign mounting. This sleek aluminum gripper requires no drilling into your substrate making it versatile in all environments. Easy to mount, these holders permit a wide range of material thicknesses to be confidently secured. Mount singularly or in pairs. Accommodates inserts up to 5/16" thick.



Finished Example



Available in Satin Silver:



Gyford CESCO Standoff Surface Mount Kit

Gyford CESCO Standoff Surface Mount kit is perfect to flush mount signs, artwork and panels to a wall. Use these Surface Mount Standoff kits to add slight dimension to your designs and give your project a finished look. Each kit includes a set of four (4) caps and mounting hardware for a variety of material thicknesses.



Finished Example



Available

1" D	1" L
1/2" D	1/2" L
3/4" D	3/4" L

Available in four finishes:



Aluminum



Matte Black



Matte Silver



Matte Gold

CESCO Standoffs

Standoffs are designed to mount signs, artwork, etc. at a fixed distance from the surface. Use Standoffs to add dimension to your designs.

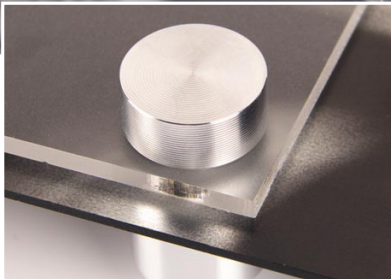
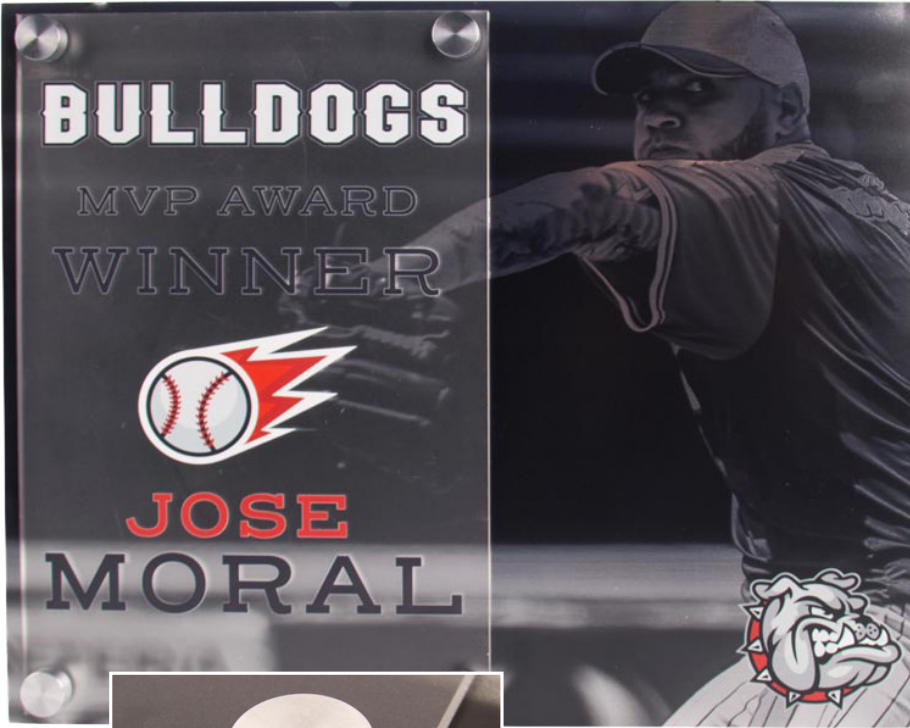

Finished Example

Available	
1" D	1" L
1/2" D	1/2" L
3/4" D	3/4" L



Available in four finishes:



Aluminum



Matte Black



Matte Silver



Matte Gold



Frame Accessories



Suction Cups

Sign inserts and lenses can easily be inserted and removed using convenient suction cups with removal hook. These suction cups include a hook for hanging signs on windows or glass doors, suction cups are a sign shop staple. They can easily remove sign inserts and lenses from frames.



Partition Mount

Partition Pin

Partitions

Partition pins make attaching nameplates to a cloth cubicle wall simple! These pins can also be used with other light weight objects that you are displaying in your office space. Most items require 2 pins to securely hang on a cubicle or partition wall.

A barbed mounting pin designed for use on some of today's woven knit fabric coverings of partitioned office systems, cubicles, workstations and soft walls. Great for hanging sign frames, signs, pictures, and poster wall displays. A durable product that will withstand multiple relocations of the sign with minimal damage to woven knit fabrics. Barb pin is 1" x 1" with four barbs and is made of zinc plated steel.



Item Number	Recommended Products
900 084	CESCO Wall 1/16" CESCO Architect Plastic CESCO Design
900 084A	CESCO Wall 1/16" CESCO Architect Plastic CESCO Design

CESCO Clear Plastic Cubicle Hanger

Mount office signs and nameplates over the top of partitions with this cubicle hanger. Two per case.

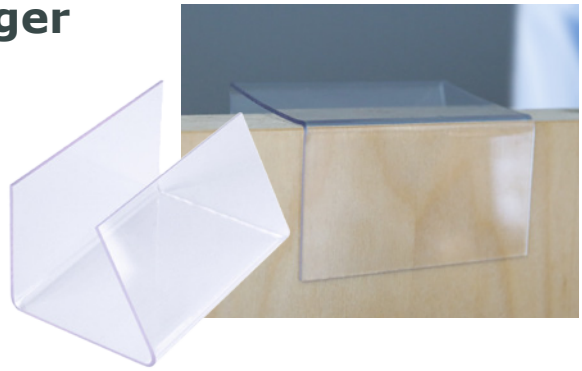

Item Number	Recommended Products
9PR110	CESCO Wall 1/16" CESCO Wall 1/8" CESCO Ribbed Wall

CESCO Dual-Lock with Adhesive Backing

Fitting perfectly into the grooves on CESCO Premier and Design frames, CESCO Dual-Lock is a great way to secure your sign into its frame. The adhesive backed Dual-Lock give an audible snap to insure positive locking. Inserts are easily removed and changed using suction cups. Sold individually, must buy two to get both top and bottom.



Item Number	Size	Recommended Products
99D-512	1/2" X 12"	CESCO Wall 1/16" CESCO Wall 1/8" CESCO Ribbed Wall

CESCO Inserts for Architect Frames

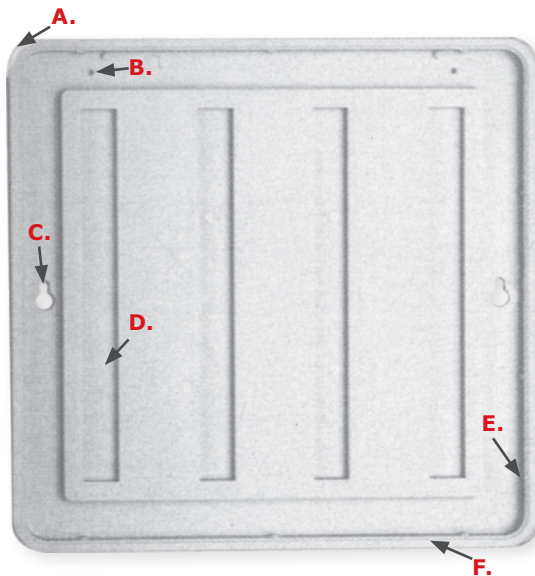

- A.** 3/8" inside radius
- B.** Pin for mounting to fabric covered partitions
- C.** Keyhole mounting
- D.** 1/2" trough for mounting 3M DUAL LOCK™
- E.** Front Reveal
- F.** 1/8" frame thickness

Design Frames

Design Frame System is designed for quality interior signage. Several unique features offered by this system will make designing and mounting interior signage simple. Frames are 1/8" smaller than designated size to provide maximum yield of 24" x 48" sheet when using saw cut or sheared strips.

- Five (5) colours: Light Grey (Pewter), Medium Grey, Almond, Black, Brown
- Designed for 1/16" material, with 3/8" radius corners
- Keyhole mounting allows for permanent or removable frames
- Wire clip mounts into frame for hanging on office partitions
- Snap Wire in place between frame and peg. Apply adhesive inside frame over wire if permanent wire placement is required.
- Features Dual Lock™ fastening system for attaching insert strips. Tamper resistant, but plates can be removed with suction cup.
- 'Header' messages can be permanently mounted with tape, while Dual Lock™ tabs can be placed at ANY LEVEL for interchangeable messages
- Double-sided frames are available for corridor brackets. Bracket mounts to plate. Bracket is mounted to wall with concealed screws.

CESCO Wire Clip for Design Frame

Wire clips are designed to compliment the CESCO Design Series frames and allow for easy mounting on fabric covered partitions.

Item Number	Size	Recommended Products
WCLIP3	3"	CESCO Design Frame
99W 600	6"	CESCO Design Frame

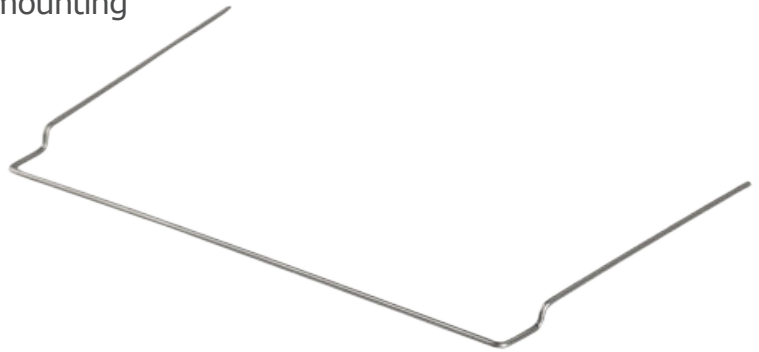

CESCO Corridor Substrate Hardware Mounting

Easily mount substrates to our CESCO Corridor Brackets with this hardware. Four per pack.

Item Number	Caps	Screws	Color	Recommended Products
938R	10C	10S	Rose Gold	CESCO Corridor
938R	20C	20S	Silver	CESCO Corridor
938R	40C	40S	Matte Black	CESCO Corridor
938R	70C	70S	Yellow	CESCO Corridor

Available in four anodized finishes:

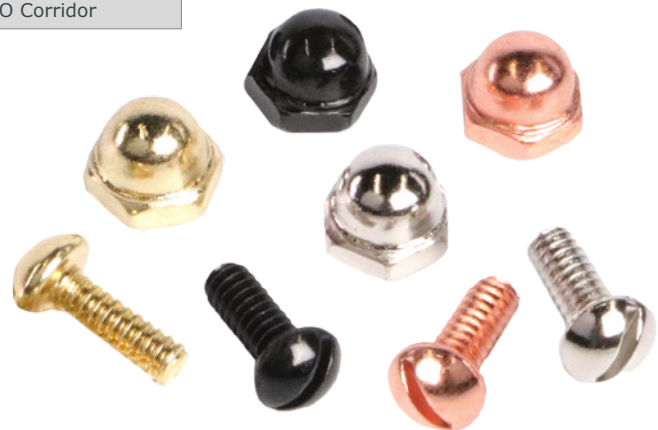

CUTTING EQUIPMENT FOR INSERTS

Plastic inserts using any colour of Rowmark materials can be used. For square corners use a plastic shear, for round corners use a corner rounder base and die 3/8" radius to match the inside corners.

Plastic Shear

SHR-P12-AC



- 12" Blade
- Bronze bushings for durability
- Size: 16" x 19" x 10"
- Weight: approx. 35 lbs.
- Sharp upper blade for plastic only
- Long handle for maximum shear power

Description	Part No.
Plastic Shear with 12" blade	SHR-P12-AC
Upper metal replacement blade	SHR-UP1
Your shear blade re-sharpened	SHR-999

Corner Rounders

Standard Cornermate® Base
CRN-000 • Die Sold Separately

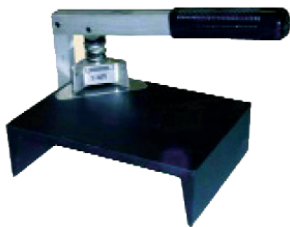

- Standard table
- **Size:** 10"L x 6.5"W x 6"H
- **Weight:** approx. 6 lbs. (with cutting unit)
- **Capacity:** Aluminum .040" (hole punch capacity .025")
Brass .025" (hole punch capacity .020")
Steel .015"
Flexible Plastic .063"
- Corners without burrs or distortions
- Standard Cornermate® & EZ-Cornermate® share the same die sizes

Die



Radius die
(See chart for part # for dies)

Die	Radius	Notched	Scallop	Chamfer	Hole	Slot*
3/32"					DIE-032HP	
1/8"	DIE-018R	DIE-018N			DIE-018HP	DIE-SLT
3/16"	DIE-316R	DIE-316N			DIE-316HP	
1/4"	DIE-025R	DIE-025N	DIE-025S	DIE-025C		
5/16"	DIE-516R					
3/8"	DIE-038R	DIE-038N	DIE-038S	DIE-038C		
1/2"	DIE-050R	DIE-050N	DIE-050S			
3/4"	DIE-075R	DIE-075N				
1"	DIE-100R	DIE-100N				

*Slot measures: 1/4" x 9/16"

SHEAR AND ROUNDERS

Terms and Conditions of Sale



GENERAL

1. All accounts are sold C.O.D. certified cheque, cash, credit card or e-transfer only.
2. Net 30 Days (approved accounts only). Credit must be applied for on our credit application form.
3. A service charge of 2% (two per cent) per month will be assessed on past due accounts.
4. Delinquent accounts over 60 days will be placed on credit hold, and may revert to COD terms.
5. There will be a \$45.00 Service Charge for returned cheques.
6. All discrepancies on shipment MUST be reported immediately.



PRICING

1. Prices and specifications are subject to change without notice.
2. All prices are NET prices. Effective prices shall be those on most current price list.
3. GST/HST is applicable on all merchandise.
4. Minimum order is \$25.00 for Net 30 day accounts. or small order fee will be applied.

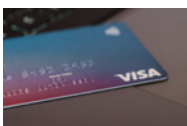

CREDIT CARDS

1. VISA, MASTERCARD and AMEX credit cards are accepted.
2. Visa, Mastercard – Minimum \$50.00 or a small order fee of \$5.00 will be applied to the invoice.
3. Amex – Minimum \$100.00 or a small order fee of \$10.00 will be applied to the invoice.
4. Credit cards are not accepted on Net 30 day accounts once terms have been extended.



FREIGHT

1. All goods are shipped F.O.B. Canadian Engravers Supply, prepaid and charged. Unless specifically noted.
2. Otherwise shipping and handling charges will be added to the invoice.
3. All courier freight collect orders under \$500.00 are subject to a small handling/packing fee.

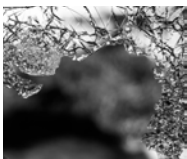

GOODS DAMAGED IN TRANSIT

1. The customer is responsible to check all parcels received for any damages by freight carrier.
2. If damages occur, the customer is to advise the carrier upon receipt of the goods and sign for the goods as damaged or subject to inspection.
3. Keep all packaging, and advise our office immediately for claim instructions.

NOTE: Carriers will refuse any claim if they are not advised immediately (within 48 hours).



RETURNED GOODS

1. CUSTOM FABRICATED, NON-STOCK ITEMS, MACHINES, AUXILLARY EQUIPMENT AND PARTS ARE NOT ELIGIBLE FOR RETURN. ALL ARE FINAL SALES.
2. Stock items are not eligible for return after 30 days.
3. Merchandise returns require a return goods authorization number. When calling, notify our Customer Service Department with product number and our invoice or packing slip number.
4. A credit will be applied to the customer's account for returned goods, provided products are in the original packaging and are received in good condition. No refund cheques are issued.
5. Credits will not be refunded to credit cards, only applied to the customers accounts for use on next order.
6. Eligible returned goods are subject to 20% restocking charge, with a minimum charge of \$25.00.



WARRANTY / DISCLAIMER

The following warranty is in lieu of all warranties expressed or implied and covers all products sold by Canadian Engravers Supply Company Ltd. SPECIACALLY, SELLER AND MANUFACTURER DISCLAIM WARRANTY OF MERCHANTABILITY OF OR FITNESS FOR A PARTICULAR PURPOSE and manufacturers/sellers only obligation shall be to replace such quantity of the product proved to be defective. Neither seller nor manufacturer shall be liable for any injury, loss or damage, direct or consequential, arising out of the use of, or the inability to use the product. Before using, User shall determine the suitability of the product for his intended use and user assumes all risk and liability whatsoever in connection therewith. The foregoing may not be altered except by an agreement signed by officers of sellers and manufacturers.

2023 HOLDERS & FRAMES

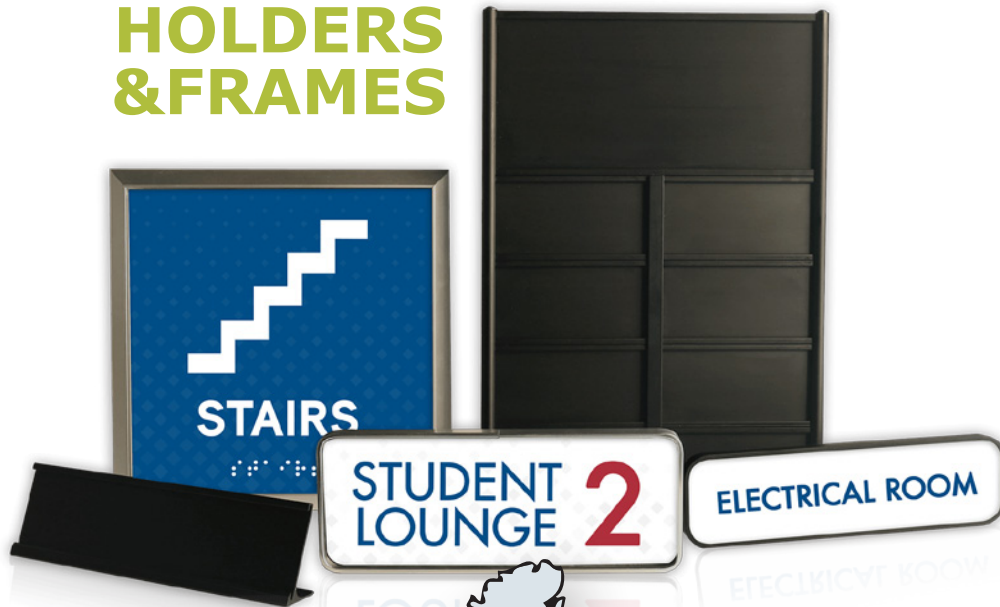

CANADIAN ENGRAVERS SUPPLY COMPANY LTD.
Mississauga | 905-795-1262 or 1-877-795-1262
sales@cesco.ca | www.cesco.ca



CANADIAN ENGRAVERS SUPPLY ALBERTA LTD.
Calgary | 403-250-6774 or 1-877-775-6774
salesab@cesco.ca | www.cesco.ca